

Easy-to-use, Simple Magnetic Proximity Sensor

- Permanent magnetic used to operate the reed switch.
- Ideal for detecting opening and closing of doors.

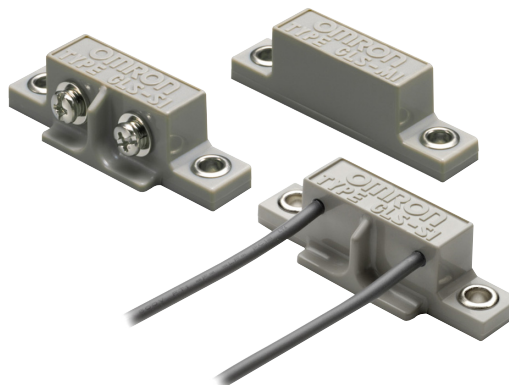

Be sure to read *Safety Precautions* on page 2.

For the most recent information on models that have been certified for safety standards, refer to your OMRON website.

Ordering Information

Terminal Block Model (Sensor)

Name	Model
Set	GLS-1
Sensor	GLS-S1
Magnet	GLS-M1

Pre-wired Model (Sensor)

Name	Model
Set	GLS-1L
Sensor	GLS-S1-L 1M

Note: A magnet of the Pre-wired Model can not be purchased separately. The magnet specifications are different for Pre-wired Models and Terminal Block Models.

Ratings and Specifications

Item	Model	GLS-1	GLS-1L
Sensing distance		15 mm *1	
Contact circuit		SPST-NO	
Switching capacity *2		Maximum operating voltage: 100 VDC Maximum operating current: 0.1 A DC Maximum switching capacity: 10 W (for both open and closed contacts)	
Contact dielectric strength		250 VDC for 1 min with a leakage current of 1 mA max.	
Response frequency		20 Hz max.	
Ambient temperature range		Operating/Storage: -20 to 60°C (with no icing or condensation)	
Ambient humidity range		Operating/storage: 35% to 85% (with no condensation)	
Contact resistance		150 mΩ max.	250 mW max. (including conductor resistance of lead wire)
Dielectric strength		1,000 VAC for 1 min between terminals and case	
Life expectancy		50,000,000 times min. with 0.1-A resistive load at 24 VDC	
Vibration resistance		Destruction: 10 to 55 Hz, 1.5-mm double amplitude for 2 hours each in X, Y, and Z directions	
Shock resistance		Destruction: 300 m/s ² 3 times each in X, Y, and Z directions	
Degree of protection		IP40 (IEC)	
Connection method		Terminal block	Pre-wired (standard cable length: 1 m)
Materials	Sensor	ABS	
	Magnet		

*1. Notice that the actual distance is 15 mm min.

*2. AC power cannot be used.

Safety Precautions

Refer to *Warranty and Limitations of Liability*.

⚠ WARNING

This product is not designed or rated for ensuring safety of persons either directly or indirectly. Do not use it for such purposes.



Precautions for Correct Use

Do not use this product under ambient conditions that exceed the ratings.

● **Design**

Sensing area

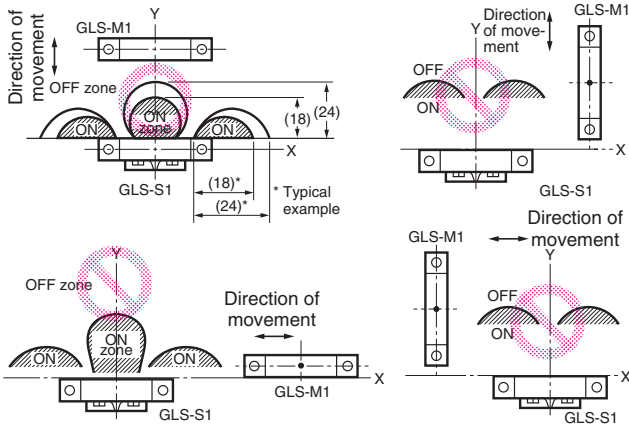

● **Mounting**

Mounting

The characteristics of the GLS will change if the GLS is mounted to ferrous materials, such as a steel plate.

● **Wiring**

Internal Wiring Diagram

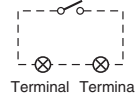

● **Miscellaneous**

Do not impose excessive shock on the Sensor (e.g., dropping the Sensor from a height of 800 mm or more). Otherwise, the Sensor may malfunction.

Dimensions

(Unit: mm)
Tolerance class IT16 applies to dimensions in this data sheet unless otherwise specified.

Sensor (terminal block)
GLS-S1

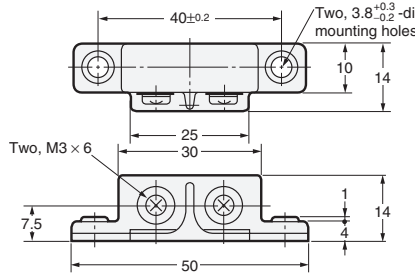
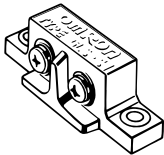

Note: Tighten each M3 screw of the terminal block to a torque of 0.59 N·m. max.

Sensor (pre-wired)
GLS-S1-L

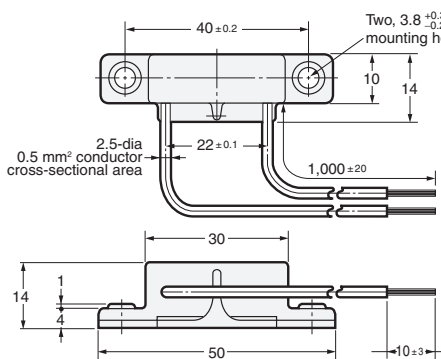
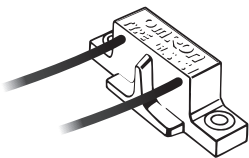

Magnet
GLS-M1

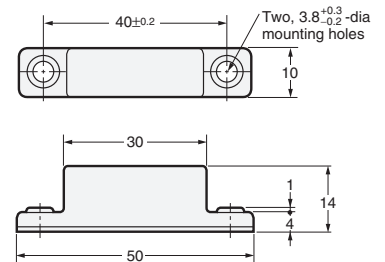
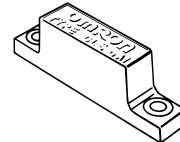

Note: The shape of the magnet is the same for Pre-wired Models and Terminal Block Models, but the magnet specifications are different.

Terms and Conditions Agreement

Read and understand this catalog.

Please read and understand this catalog before purchasing the products. Please consult your OMRON representative if you have any questions or comments.

Warranties.

(a) Exclusive Warranty. Omron's exclusive warranty is that the Products will be free from defects in materials and workmanship for a period of twelve months from the date of sale by Omron (or such other period expressed in writing by Omron). Omron disclaims all other warranties, express or implied.

(b) Limitations. OMRON MAKES NO WARRANTY OR REPRESENTATION, EXPRESS OR IMPLIED, ABOUT NON-INFRINGEMENT, MERCHANTABILITY OR FITNESS FOR A PARTICULAR PURPOSE OF THE PRODUCTS. BUYER ACKNOWLEDGES THAT IT ALONE HAS DETERMINED THAT THE PRODUCTS WILL SUITABLY MEET THE REQUIREMENTS OF THEIR INTENDED USE.

Omron further disclaims all warranties and responsibility of any type for claims or expenses based on infringement by the Products or otherwise of any intellectual property right. (c) Buyer Remedy. Omron's sole obligation hereunder shall be, at Omron's election, to (i) replace (in the form originally shipped with Buyer responsible for labor charges for removal or replacement thereof) the non-complying Product, (ii) repair the non-complying Product, or (iii) repay or credit Buyer an amount equal to the purchase price of the non-complying Product; provided that in no event shall Omron be responsible for warranty, repair, indemnity or any other claims or expenses regarding the Products unless Omron's analysis confirms that the Products were properly handled, stored, installed and maintained and not subject to contamination, abuse, misuse or inappropriate modification. Return of any Products by Buyer must be approved in writing by Omron before shipment. Omron Companies shall not be liable for the suitability or unsuitability or the results from the use of Products in combination with any electrical or electronic components, circuits, system assemblies or any other materials or substances or environments. Any advice, recommendations or information given orally or in writing, are not to be construed as an amendment or addition to the above warranty.

See <http://www.omron.com/global/> or contact your Omron representative for published information.

Limitation on Liability; Etc.

OMRON COMPANIES SHALL NOT BE LIABLE FOR SPECIAL, INDIRECT, INCIDENTAL, OR CONSEQUENTIAL DAMAGES, LOSS OF PROFITS OR PRODUCTION OR COMMERCIAL LOSS IN ANY WAY CONNECTED WITH THE PRODUCTS, WHETHER SUCH CLAIM IS BASED IN CONTRACT, WARRANTY, NEGLIGENCE OR STRICT LIABILITY.

Further, in no event shall liability of Omron Companies exceed the individual price of the Product on which liability is asserted.

Suitability of Use.

Omron Companies shall not be responsible for conformity with any standards, codes or regulations which apply to the combination of the Product in the Buyer's application or use of the Product. At Buyer's request, Omron will provide applicable third party certification documents identifying ratings and limitations of use which apply to the Product. This information by itself is not sufficient for a complete determination of the suitability of the Product in combination with the end product, machine, system, or other application or use. Buyer shall be solely responsible for determining appropriateness of the particular Product with respect to Buyer's application, product or system. Buyer shall take application responsibility in all cases.

NEVER USE THE PRODUCT FOR AN APPLICATION INVOLVING SERIOUS RISK TO LIFE OR PROPERTY OR IN LARGE QUANTITIES WITHOUT ENSURING THAT THE SYSTEM AS A WHOLE HAS BEEN DESIGNED TO ADDRESS THE RISKS, AND THAT THE OMRON PRODUCT(S) IS PROPERLY RATED AND INSTALLED FOR THE INTENDED USE WITHIN THE OVERALL EQUIPMENT OR SYSTEM.

Programmable Products.

Omron Companies shall not be responsible for the user's programming of a programmable Product, or any consequence thereof.

Performance Data.

Data presented in Omron Company websites, catalogs and other materials is provided as a guide for the user in determining suitability and does not constitute a warranty. It may represent the result of Omron's test conditions, and the user must correlate it to actual application requirements. Actual performance is subject to the Omron's Warranty and Limitations of Liability.

Change in Specifications.

Product specifications and accessories may be changed at any time based on improvements and other reasons. It is our practice to change part numbers when published ratings or features are changed, or when significant construction changes are made. However, some specifications of the Product may be changed without any notice. When in doubt, special part numbers may be assigned to fix or establish key specifications for your application. Please consult with your Omron's representative at any time to confirm actual specifications of purchased Product.

Errors and Omissions.

Information presented by Omron Companies has been checked and is believed to be accurate; however, no responsibility is assumed for clerical, typographical or proofreading errors or omissions.

2014.12

In the interest of product improvement, specifications are subject to change without notice.

OMRON Corporation
Industrial Automation Company

<http://www.ia.omron.com/>

(c)Copyright OMRON Corporation 2014 All Right Reserved.